

# LAKEVIEW CIRCLE DRIVE STORMWATER IMPROVEMENT PROJECT

## TOWN OF LAKE GEORGE, WARREN COUNTY, NY

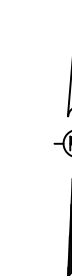

**LOCATION MAP**  
SCALE: 1"=1000'

11/13/18

INDEX OF DRAWINGS				
PAGE NO.	REV	SHEET NO.	DATE	DESCRIPTION
1	0	G001	11/13/18	TITLE SHEET
2	0	C100	11/13/18	OVERALL CONCEPT PLAN
3	0	C130	11/13/18	LIVE STAKES & BANK PROTECTION IMPROVEMENTS
4	0	C131	11/13/18	DRYWELL, CATCH BASIN & HYDRODYNAMIC UNITS PLAN
5	0	C132	11/13/18	HEADWALL DESIGN
6	0	SD1	11/13/18	SITE DETAILS

**SITE CIVIL ENGINEER AND LANDSCAPE ARCHITECT:**

CHAZEN ENGINEERING, LAND SURVEYING &  
LANDSCAPE ARCHITECTURE CO., D.P.C.  
20 ELM STREET (SUITE 110), GLENS FALLS NY 12801  
PHONE: (518) 812-0513

THE IMPROVEMENTS PRESENTED WITHIN ARE CONCEPTUAL IN NATURE AND ARE CONCEPTUALLY DESIGNED WITHOUT A FORMAL SURVEY. THE IMPROVEMENTS ARE INTENDED TO BE CONSTRUCTED BY MUNICIPAL FORCES AND AS SUCH THE LEVEL OF DETAIL IS NOT TO THE QUALITY OF A PROJECT TO BE FORMALLY BID TO A PRIVATE CONTRACTOR.

**Dig Safely.**  
New York  
Call Before You Dig  
Wait The Required Time  
Confirm Utility Response  
Respect The Marks  
Dig With Care  
800-962-7962  
www.digsafelynewyork.com

FOR DISCUSSION ONLY



ALL RIGHTS RESERVED. COPY OR REPRODUCTION OF THIS DRAWING OR DOCUMENT, OR ANY PORTION THEREOF, WITHOUT THE EXPRESS WRITTEN PERMISSION OF CHAZEN ENGINEERING, LAND SURVEYING & LANDSCAPE ARCHITECTURE CO., D.P.C. IS PROHIBITED. THIS DRAWING OR DOCUMENT IS NOT INTENDED OR REPRESENTED TO BE SUITABLE FOR ANY PURPOSE OTHER THAN THE SPECIFIC PROJECT, APPLICATION AND SITUATION FOR WHICH IT WAS INTENDED. ANY MODIFICATION OF THIS DRAWING OR DOCUMENT, OR ANY USE FOR ANY PROJECT, APPLICATION OR SITUATION OTHER THAN THAT FOR WHICH IT WAS INTENDED, WILL BE AT USER'S SOLE RISK AND WITHOUT LIABILITY TO CHAZEN ENGINEERING, LAND SURVEYING & LANDSCAPE ARCHITECTURE CO., D.P.C.

IT IS A VIOLATION OF NEW YORK STATE EDUCATION LAW FOR ANY PERSON TO ALTER THIS DRAWING OR DOCUMENT IN ANY WAY, UNLESS HE OR SHE IS ACTING UNDER THE DIRECTION OF A LICENSED DESIGN PROFESSIONAL (PROFESSIONAL ENGINEER, LAND SURVEYOR, ARCHITECT OR LANDSCAPE ARCHITECT). IF THIS DRAWING OR DOCUMENT IS ALTERED, THE ALTERING DESIGN PROFESSIONAL SHALL AFFIX TO THE DRAWING OR DOCUMENT HIS OR HER SEAL, THE NOTATION "ALTERED BY FOLLOWED BY HIS OR HER SIGNATURE, THE DATE OF SUCH ALTERATION, AND A SPECIFIC DESCRIPTION OF THE ALTERATION."

CHAZEN ENGINEERING, LAND SURVEYING & LANDSCAPE ARCHITECTURE CO., D.P.C.



Office Locations:

- Hudson Valley Office:  
21 Fox Street  
Poughkeepsie, New York 12601  
Phone: (845) 454-3980
- Capital District Office:  
547 River Street  
Troy, New York 12180  
Phone: (518) 273-0055
- Tennessee Office:  
1755 Division Street  
Nashville, Tennessee 37203  
Phone: (615) 380-1359
- North Country Office:  
20 Elm Street (Suite 110)  
Glens Falls, New York 12801  
Phone: (518) 812-0513
- Central NY Office:  
721 East Genesee Street  
Syracuse, New York 13210  
Phone: (315) 251-1013

rev.	date	description
2	4/15/2019	REVISED PER ACQE PERMIT LETTER
1	3/12/2018	REVISED PER ACQE PERMIT LETTER

LAKEVIEW CIRCLE STORMWATER PROJECTS

**TITLE SHEET**

LAKE GEORGE, WARREN COUNTY, NEW YORK

designed	checked
ZFB	
date	scale
01/30/19	NTS
project no.	
91803.03	
sheet no.	
<b>G001</b>	



- IMPROVEMENT 11  
BROOK DRIVE  
CHANNEL STABILIZATION. (2) SD-1
- IMPROVEMENT 10  
REPLACE EXISTING CATCH BASIN  
WITH CATCH BASIN (1). (3) SD-1
- IMPROVEMENT 4  
DEER RUN ROAD  
ROADSIDE DRAINAGE  
CHANNEL STABILIZATION. (2) SD-1
- IMPROVEMENT 2  
SUMMIT DRIVE DRYWELLS (3)  
AND HYDRODYNAMIC TREATMENT UNIT. (3) SD-1
- IMPROVEMENT 1  
ANTLER AVENUE (NORTH)  
ROADSIDE DRAINAGE  
CHANNEL STABILIZATION. (2) SD-1
- IMPROVEMENT 3  
DEER RUN AT ANTLER AVENUE  
HEADWALL STABILIZATION &  
INLET/OUTLET STABILIZATION. (1) SD-1, (7) SD-1
- IMPROVEMENT 8  
REPLACE EXISTING DRYWELL (1). (3) SD-1
- IMPROVEMENT 9  
BANK STABILIZATION. (2) SD-1

TAHOE RESORT  
BROOK OUTLET

ALL RIGHTS RESERVED. COPY OR REPRODUCTION OF THIS DRAWING OR DOCUMENT ON ANY FORM OR MEDIUM, WITHOUT THE WRITTEN PERMISSION OF CHAZEN ENGINEERING, LAND SURVEYING & LANDSCAPE ARCHITECTURE, CO., D.P.C. IS PROHIBITED. THIS DRAWING OR DOCUMENT IS NOT INTENDED OR REPRESENTED TO BE SUITABLE FOR ANY PURPOSES OTHER THAN THE SPECIFIC PROJECT APPLICATION AND SITUATION FOR WHICH IT WAS INTENDED. ANY REPRODUCTION OF THIS DRAWING OR DOCUMENT OR ANY USE FOR ANY PROJECT APPLICATION OR SITUATION OTHER THAN THAT FOR WHICH IT WAS INTENDED, WILL BE AT USER'S SOLE RISK AND WITHOUT LIABILITY TO CHAZEN ENGINEERING, LAND SURVEYING & LANDSCAPE ARCHITECTURE, CO., D.P.C.

IT IS A VIOLATION OF NEW YORK STATE EDUCATION LAW FOR ANY PERSON TO ALTER THIS DRAWING OR DOCUMENT IN ANY MANNER UNLESS HE OR SHE IS ACTING UNDER THE DIRECTION OF A LICENSED DESIGN PROFESSIONAL, PROFESSIONAL ENGINEER, LAND SURVEYOR, ARCHITECT OR LANDSCAPE ARCHITECT. IF THIS DRAWING OR DOCUMENT IS ALTERED, THE ALTERING DESIGN PROFESSIONAL SHALL AFFIX TO THE DRAWING OR DOCUMENT HIS OR HER SEAL, THE DATE OF ALTERATION, AND A SPECIFIC DESCRIPTION OF THE ALTERATION.

**CHAZEN ENGINEERING, LAND SURVEYING & LANDSCAPE ARCHITECTURE, CO., D.P.C.**

**THE CHAZEN COMPANIES**

Office Locations:



- Midwest Valley Office:  
21 Fox Street  
Roughneck, New York 12081  
Phone: (645) 454-3980
- Capital District Office:  
545 Rye Street  
Troy, New York 12180  
Phone: (518) 273-0055
- North Country Office:  
378 Bay Road  
Queensbury, New York 12804  
Phone: (518) 852-0913
- Tremont Office:  
1033 Demarest Street, Suite 300  
Northville, Tennessee 37207  
Phone: (615) 380-1359
- Central NY Office:  
721 East Genesee Street  
Syracuse, New York 13210  
Phone: (315) 221-1013

REV	DATE	BY	DESCRIPTION
1	3/02/19	REVIEW PER AEC PERMIT LETTER	

**OVER ALL CONCEPT PLAN  
LAKEVIEW CIRCLE STORMWATER IMPROVEMENTS PROJECTS  
TOWN OF LAKE GEORGE, WARREN COUNTY, NY**

DESIGNED	CHECKED
2/18	TCC
DATE	SCALE
01/30/19	1"=100'
PROJECT NO.	
91803.03	
SHEET NO.	
<b>C100</b>	

**SITE LEGEND:**

-  LIVE STAKE
-  RIP RAP
-  SILT SOCKS (GROSOX)

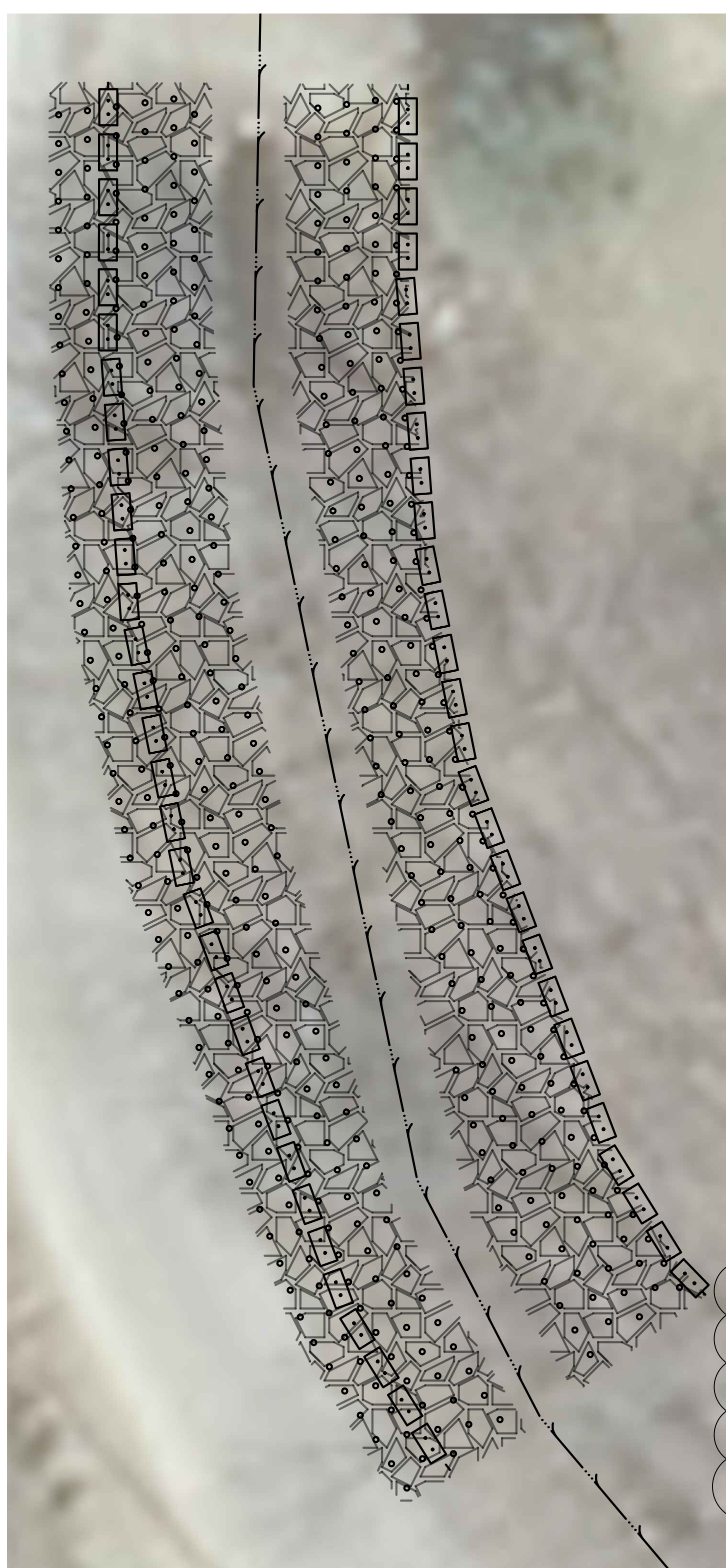

**1 IMPROVEMENT 9**  
SCALE: 1" = 10'

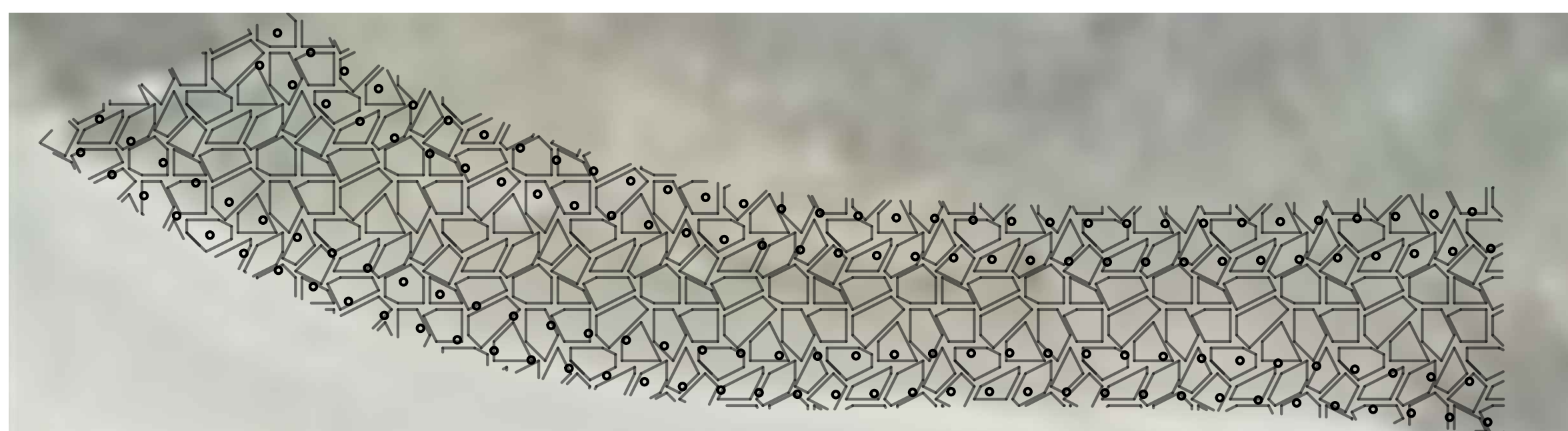

**2 IMPROVEMENT 1**  
SCALE: 1" = 10'

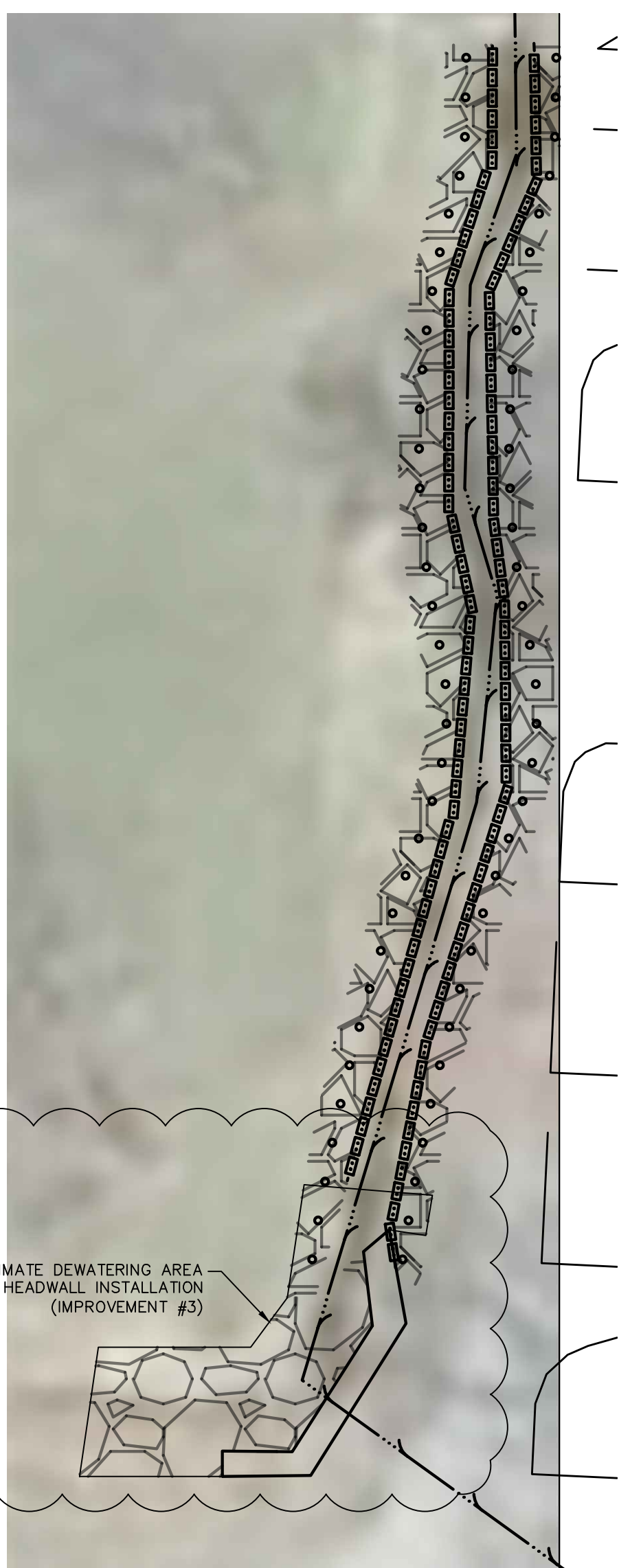

**3 IMPROVEMENT 3**  
SCALE: 1" = 10'

APPROXIMATE DEWATERING AREA FOR HEADWALL INSTALLATION (IMPROVEMENT #3)

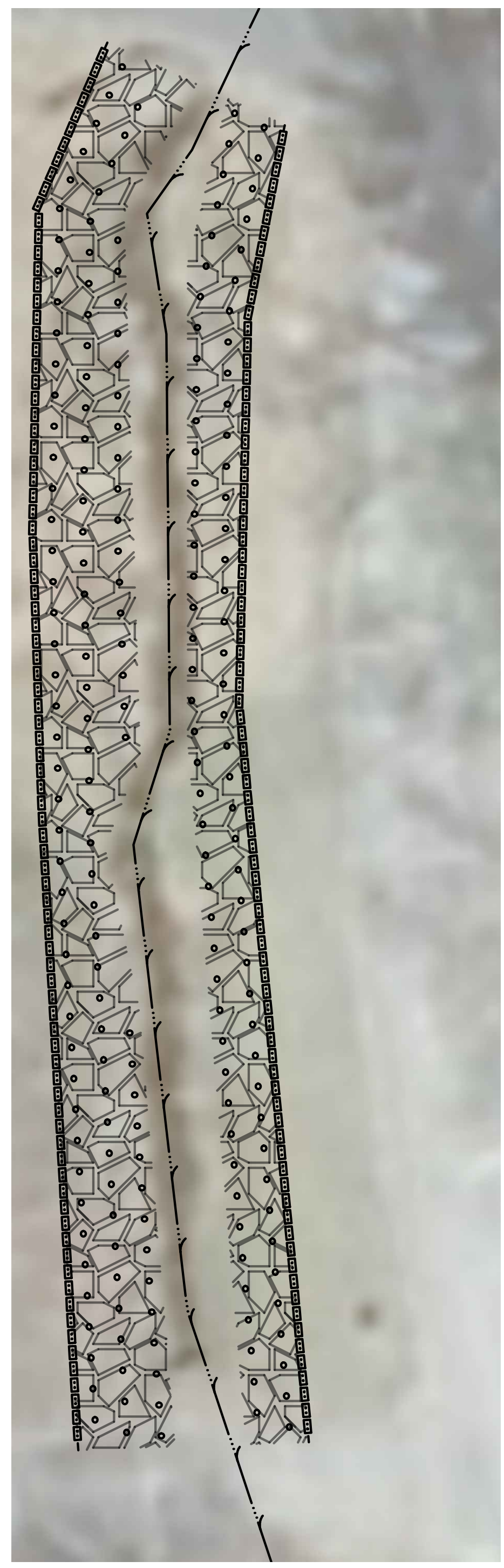

**4 IMPROVEMENT 11**  
SCALE: 1" = 10'

IMPROVEMENT NUMBER	NUMBER OF LIVE STAKES
1	144
4	64
9	466
11	206
<b>TOTAL NUMBER NEEDED</b>	<b>880</b>

**5 LIVE STAKE SCHEDULE**  
SCALE: NOT TO SCALE

EXCAVATION TO OCCUR IN THE SUMMER MONTHS WHEN STREAM CHANNELS ARE DRY. ALTHOUGH IT IS HIGHLY UNLIKELY, DEPOSIT MATERIALS SHALL BE PUT DIRECTLY INTO A DUMP TRUCK AND HAULED AWAY THE SAME DAY.

FOR DISCUSSION ONLY

ALL RIGHTS RESERVED. COPY OR REPRODUCTION OF THIS DRAWING OR DOCUMENT, OR ANY PORTION THEREOF, WITHOUT THE EXPRESS WRITTEN PERMISSION OF CHAZEN ENGINEERING, LAND SURVEYING & LANDSCAPE ARCHITECTURE CO., D.P.C. IS PROHIBITED. THIS DRAWING OR DOCUMENT IS NOT INTENDED OR REPRESENTED TO BE SUITABLE FOR ANY PURPOSE OTHER THAN THE SPECIFIC PROJECT, APPLICATION AND SITUATION FOR WHICH IT WAS INTENDED. ANY MODIFICATION OF THIS DRAWING OR DOCUMENT, OR ANY USE FOR ANY PROJECT, APPLICATION OR SITUATION OTHER THAN THAT FOR WHICH IT WAS INTENDED, WILL BE AT USER'S SOLE RISK AND WITHOUT LIABILITY TO CHAZEN ENGINEERING, LAND SURVEYING & LANDSCAPE ARCHITECTURE CO., D.P.C.

IT IS A VIOLATION OF NEW YORK STATE EDUCATION LAW FOR ANY PERSON TO ALTER THIS DRAWING OR DOCUMENT IN ANY WAY, UNLESS HE OR SHE IS ACTING UNDER THE DIRECTION OF A LICENSED DESIGN PROFESSIONAL (PROFESSIONAL ENGINEER, LAND SURVEYOR, ARCHITECT OR LANDSCAPE ARCHITECT). IF THIS DRAWING OR DOCUMENT IS ALTERED, THE ALTERING DESIGN PROFESSIONAL SHALL AFFIX TO THE DRAWING OR DOCUMENT HIS OR HER SEAL, THE NOTATION "ALTERED BY FOLLOWED BY HIS OR HER SIGNATURE, THE DATE OF SUCH ALTERATION, AND A SPECIFIC DESCRIPTION OF THE ALTERATION."

**CHAZEN ENGINEERING, LAND SURVEYING & LANDSCAPE ARCHITECTURE, CO., D.P.C.**

**THE Chazen COMPANIES**  
Proud to be Employee Owned

Office Locations:

- Hudson Valley Office: 21 Fox Street, Poughkeepsie, New York 12601, Phone: (845) 454-3980
- Capital District Office: 647 River Street, Troy, New York 12180, Phone: (518) 273-0055
- Tennessee Office: 1705 Division Street, Nashville, Tennessee 37203, Phone: (615) 380-1359
- North Country Office: 20 Elm Street (Suite 110), Glens Falls, New York 12801, Phone: (518) 812-0513
- Central NY Office: 721 East Genesee Street, Syracuse, New York 13210, Phone: (315) 251-1013

Engineers  
Land Surveyors  
Planners  
Environmental & Safety Professionals  
Landscape Architects

rev.	date	description
2	4/15/2019	REVISED PER ACOE PERMIT LETTER
1	3/12/2018	REVISED PER ACOE PERMIT LETTER

LAKEVIEW CIRCLE STORMWATER PROJECTS

**LIVE STAKES & BANK PROTECTION IMPROVEMENTS**

LAKE GEORGE, WARREN COUNTY, NEW YORK

designed	checked
ZFB	AS NOTED
date	scale
01/30/19	AS NOTED
project no.	
91803.03	
sheet no.	
	<b>C130</b>

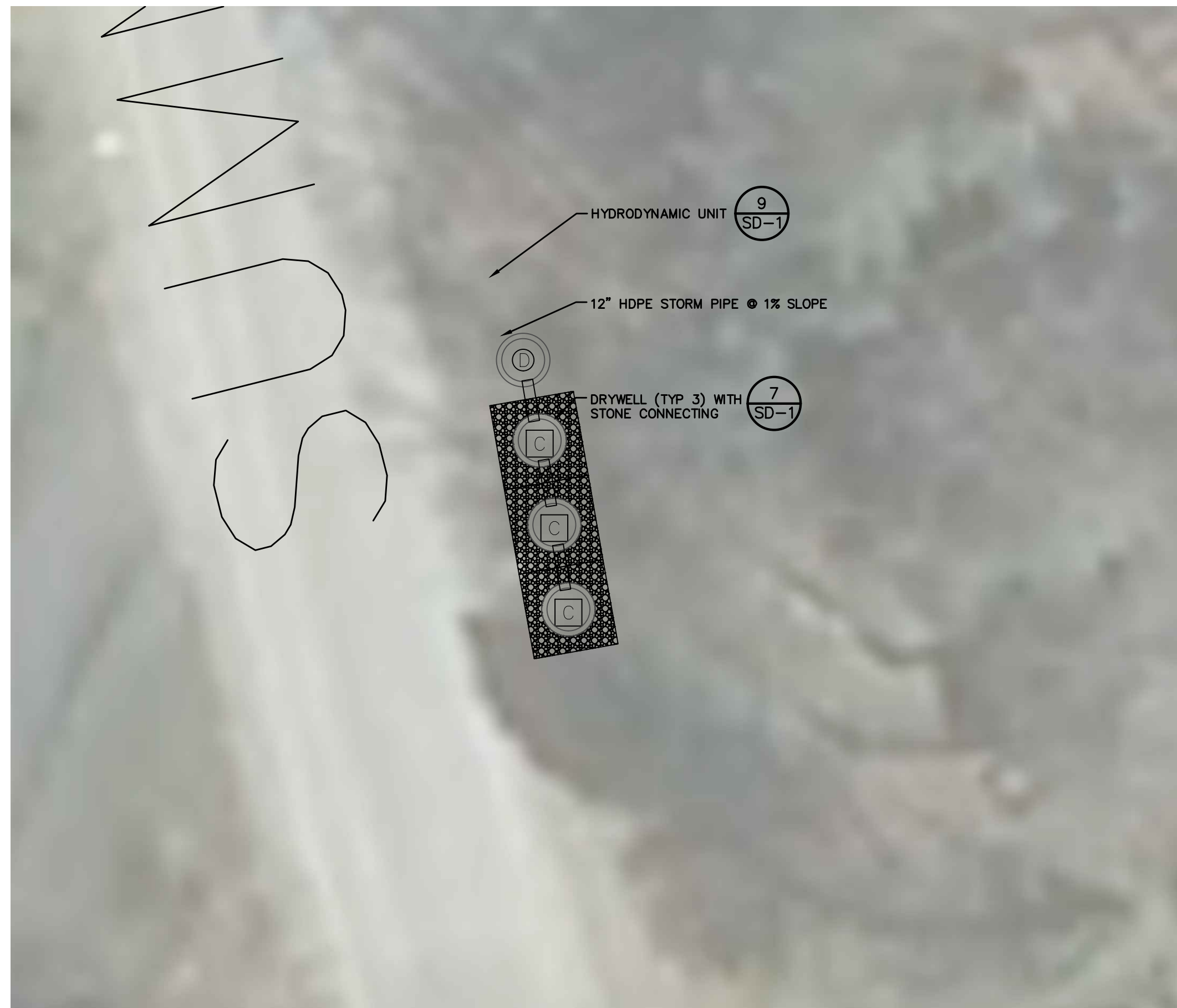

1 IMPROVEMENT 2  
SCALE: 1"=10'

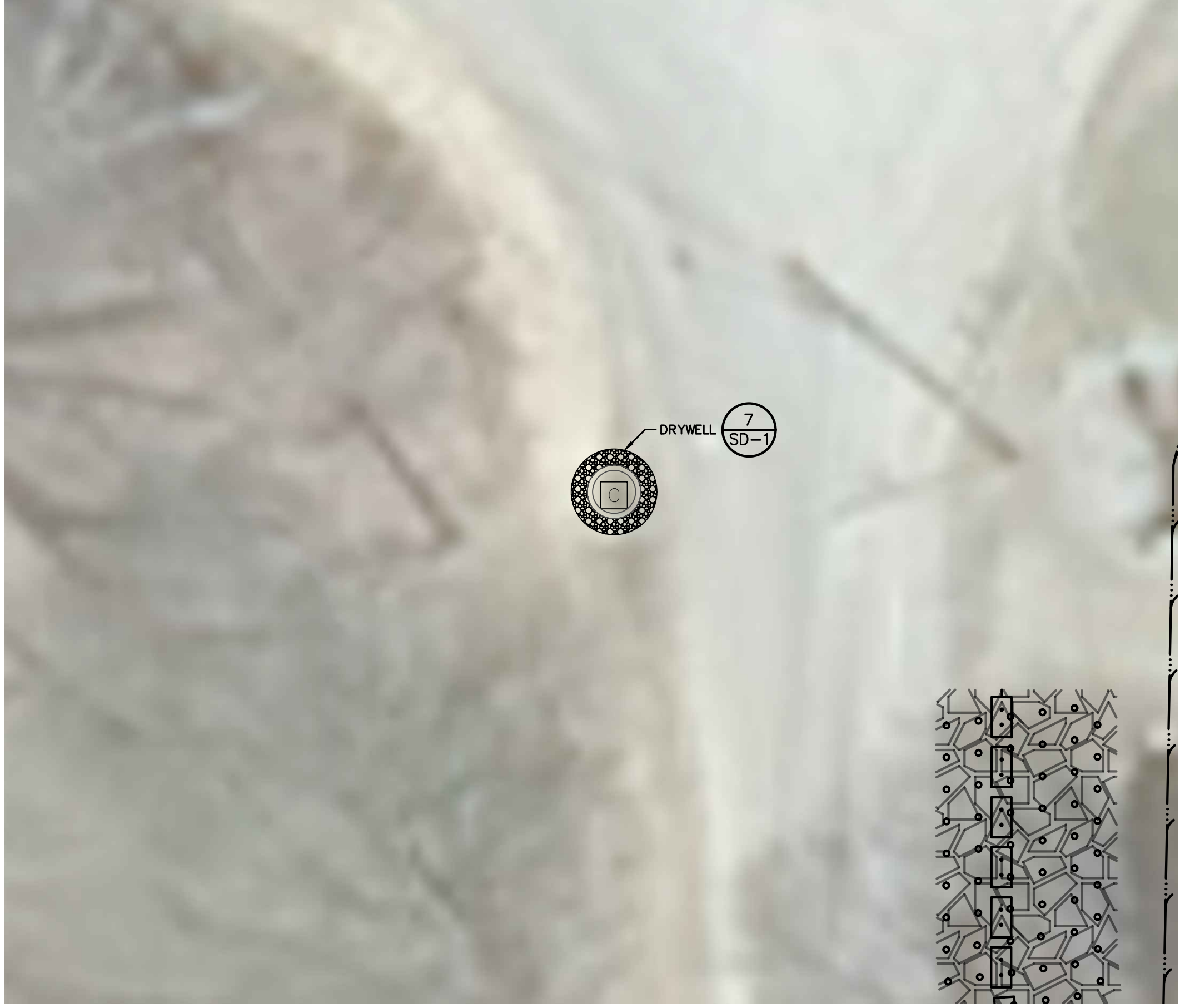



2 IMPROVEMENT 8  
SCALE: 1"=10'

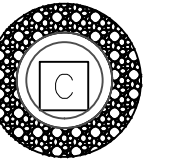
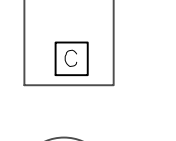

3 LAKEVIEW/PINE CATCH BASIN  
SCALE: 1"=10'

SITE LEGEND:

-  DRYWELL
-  CATCH BASIN
-  HYDRODYNAMIC UNIT

FOR DISCUSSION ONLY

ALL RIGHTS RESERVED. COPY OR REPRODUCTION OF THIS DRAWING OR DOCUMENT, OR ANY PORTION THEREOF, WITHOUT THE EXPRESS WRITTEN PERMISSION OF CHAZEN ENGINEERING, LAND SURVEYING & LANDSCAPE ARCHITECTURE CO., D.P.C. IS PROHIBITED. THIS DRAWING OR DOCUMENT IS NOT INTENDED OR REPRESENTED TO BE SUITABLE FOR ANY PURPOSE OTHER THAN THE SPECIFIC PROJECT, APPLICATION AND SITUATION FOR WHICH IT WAS INTENDED. ANY MODIFICATION OF THIS DRAWING OR DOCUMENT, OR ANY USE FOR ANY PROJECT, APPLICATION OR SITUATION OTHER THAN THAT FOR WHICH IT WAS INTENDED, WILL BE AT USER'S SOLE RISK AND WITHOUT LIABILITY TO CHAZEN ENGINEERING, LAND SURVEYING & LANDSCAPE ARCHITECTURE CO., D.P.C.

IT IS A VIOLATION OF NEW YORK STATE EDUCATION LAW FOR ANY PERSON TO ALTER THIS DRAWING OR DOCUMENT IN ANY WAY, UNLESS HE OR SHE IS ACTING UNDER THE DIRECTION OF A LICENSED DESIGN PROFESSIONAL (PROFESSIONAL ENGINEER, LAND SURVEYOR, ARCHITECT OR LANDSCAPE ARCHITECT). IF THIS DRAWING OR DOCUMENT IS ALTERED, THE ALTERING DESIGN PROFESSIONAL SHALL AFFIX TO THE DRAWING OR DOCUMENT HIS OR HER SEAL, THE NOTATION "ALTERED BY FOLLOWED BY HIS OR HER SIGNATURE, THE DATE OF SUCH ALTERATION, AND A SPECIFIC DESCRIPTION OF THE ALTERATION."

CHAZEN ENGINEERING, LAND SURVEYING & LANDSCAPE ARCHITECTURE, CO., D.P.C.

**THE Chazen COMPANIES**  
Proud to be Employee Owned

Office Locations:

- Hudson Valley Office: 21 Fox Street, Poughkeepsie, New York 12601, Phone: (845) 454-3980
- North Country Office: 20 Elm Street (Suite 110), Glens Falls, New York 12901, Phone: (518) 812-0513
- Capital District Office: 547 River Street, Troy, New York 12180, Phone: (518) 273-0055
- Central NY Office: 721 East Genesee Street, Syracuse, New York 13210, Phone: (315) 251-1013
- Tennessee Office: 1705 Division Street, Nashville, Tennessee 37203, Phone: (615) 380-1359

rev.	date	description
2	4/15/2019	REVISED PER ACOE PERMIT LETTER
1	3/12/2018	REVISED PER ACOE PERMIT LETTER

LAKEVIEW CIRCLE STORMWATER PROJECTS

**DRYWELL, CATCH BASIN, & HYDRODYNAMIC UNIT PLANS**

LAKE GEORGE, WARREN COUNTY, NEW YORK

designed	checked
ZFB	AS NOTED
date	scale
01/30/19	AS NOTED
project no.	
91803.03	
sheet no.	
	<b>C131</b>

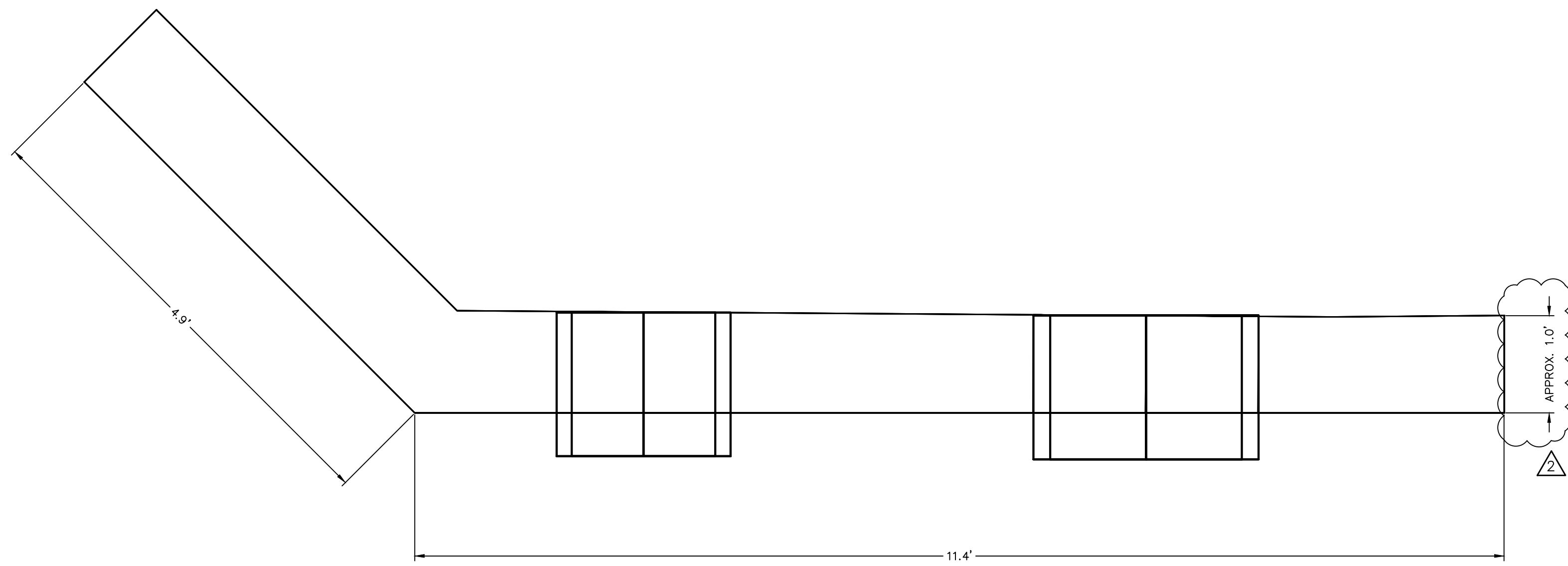

TOP VIEW

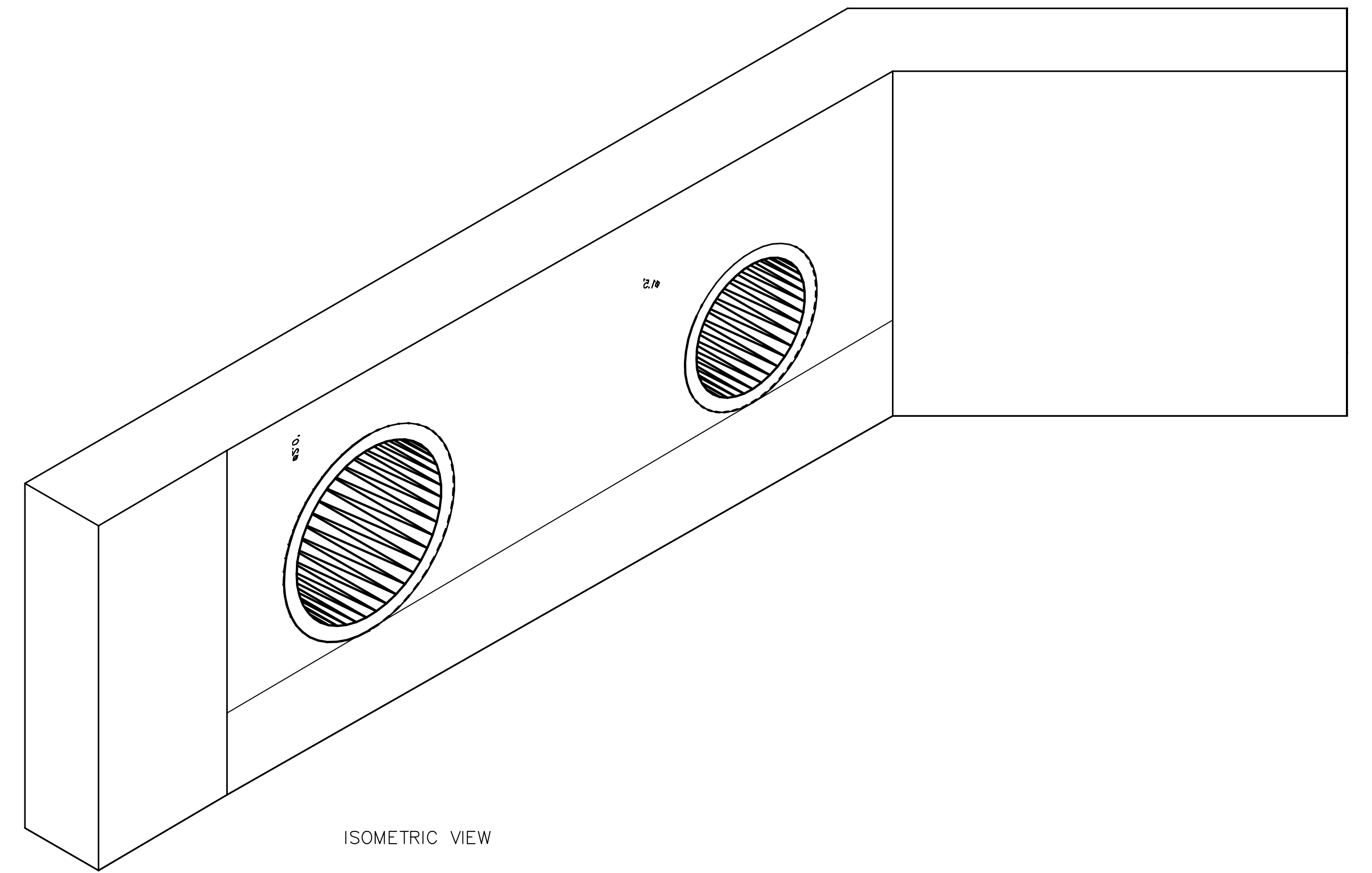

ISOMETRIC VIEW

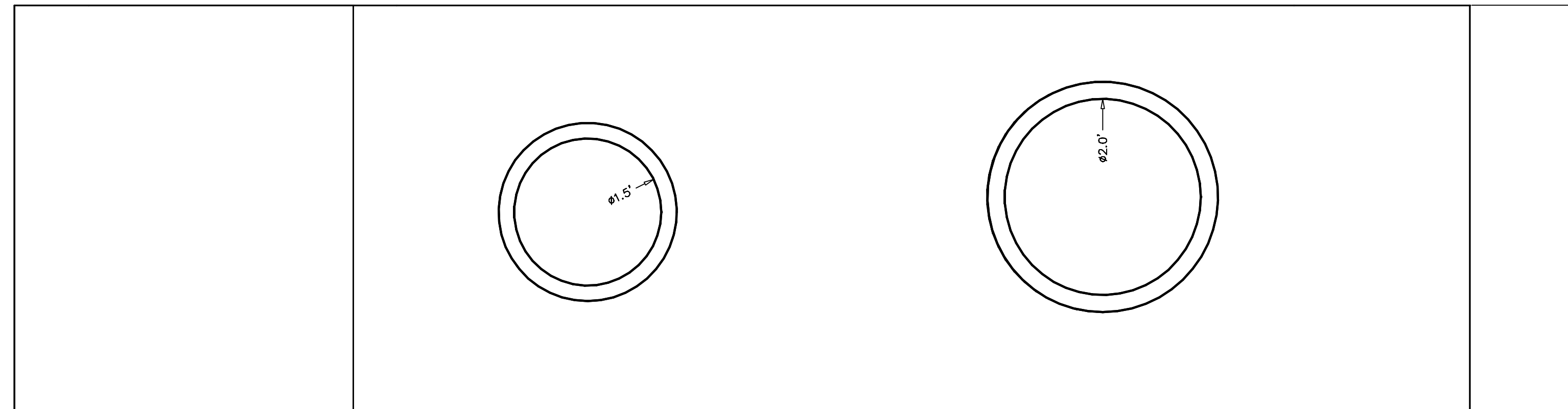

BACK VIEW

**NOTE:**

1. THIS SKETCH IS CONCEPTUAL IN NATURE AND ALL DIMENSIONS ARE SUBJECT TO CHANGE AS DESIGN PROGRESSES. THE HEADWALL IS TO BE CONSTRUCTED BY MUNICIPAL FORCES.
2. THE HEADWALL SHALL BE CAST IN A WATER TIGHT FORM.

EXCAVATION TO OCCUR IN THE SUMMER MONTHS WHEN STREAM CHANNELS ARE DRY. ALTHOUGH IT IS HIGHLY UNLIKELY, DEPOSIT MATERIALS SHALL BE PUT DIRECTLY INTO A DUMP TRUCK AND HAULED AWAY THE SAME DAY.

FOR DISCUSSION ONLY

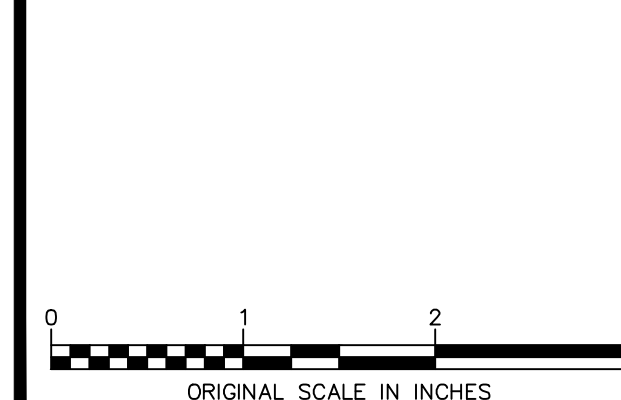

ALL RIGHTS RESERVED. COPY OR REPRODUCTION OF THIS DRAWING OR DOCUMENT, OR ANY PORTION THEREOF, WITHOUT THE EXPRESS WRITTEN PERMISSION OF CHAZEN ENGINEERING, LAND SURVEYING & LANDSCAPE ARCHITECTURE CO., D.P.C. IS PROHIBITED. THIS DRAWING OR DOCUMENT IS NOT INTENDED OR REPRESENTED TO BE SUITABLE FOR ANY PURPOSE OTHER THAN THE SPECIFIC PROJECT, APPLICATION AND SITUATION FOR WHICH IT WAS INTENDED. ANY MODIFICATION OF THIS DRAWING OR DOCUMENT, OR ANY USE FOR ANY PROJECT, APPLICATION OR SITUATION OTHER THAN THAT FOR WHICH IT WAS INTENDED, WILL BE AT USER'S SOLE RISK AND WITHOUT LIABILITY TO CHAZEN ENGINEERING, LAND SURVEYING & LANDSCAPE ARCHITECTURE CO., D.P.C.

IT IS A VIOLATION OF NEW YORK STATE EDUCATION LAW FOR ANY PERSON TO ALTER THIS DRAWING OR DOCUMENT IN ANY WAY, UNLESS HE OR SHE IS ACTING UNDER THE DIRECTION OF A LICENSED DESIGN PROFESSIONAL (PROFESSIONAL ENGINEER, LAND SURVEYOR, ARCHITECT OR LANDSCAPE ARCHITECT). IF THIS DRAWING OR DOCUMENT IS ALTERED, THE ALTERING DESIGN PROFESSIONAL SHALL AFFIX TO THE DRAWING OR DOCUMENT HIS OR HER SEAL, THE NOTATION "ALTERED BY FOLLOWED BY HIS OR HER SIGNATURE, THE DATE OF SUCH ALTERATION, AND A SPECIFIC DESCRIPTION OF THE ALTERATION."

**CHAZEN ENGINEERING, LAND SURVEYING & LANDSCAPE ARCHITECTURE, CO., D.P.C.**

**THE Chazen COMPANIES**  
Proud to be Employee Owned

Engineers  
Land Surveyors  
Planners  
Environmental & Safety Professionals  
Landscape Architects

**Office Locations:**

- Hudson Valley Office:  
21 Fox Street  
Poughkeepsie, New York 12601  
Phone: (845) 454-3980
- North Country Office:  
20 Elm Street (Suite 110)  
Glens Falls, New York 12801  
Phone: (518) 812-0513
- Capital District Office:  
647 River Street  
Troy, New York 12180  
Phone: (518) 273-0055
- Central NY Office:  
721 East Genesee Street  
Syracuse, New York 13210  
Phone: (315) 251-1013
- Tennessee Office:  
1705 Division Street  
Nashville, Tennessee 37203  
Phone: (615) 380-1359

rev.	date	description
2	4/15/2019	REVISED PER ACOE PERMIT LETTER
1	3/12/2019	REVISED PER ACOE PERMIT LETTER

LAKEVIEW CIRCLE STORMWATER PROJECTS

**HEADWALL**

LAKE GEORGE, WARREN COUNTY, NEW YORK

designed	checked
ZFB	
date	scale
01/30/19	1"=1'
project no.	
91803.03	
sheet no.	
	<b>C132</b>

STONE APRON SIZING REQUIREMENT - TABLE "A"						
CULVERT DIA. (D)	CULVERT SLOPE, %	NYSDOT STANDARD STONE FILLING MATERIAL	d50	dMAX	MINIMUM APRON THICKNESS (IN)	MINIMUM OUTLET APRON LENGTH (FT)
12"	< 8	LIGHT	6"	9"	18	10
18"	8-10	MEDIUM	9"-12"	14"-18"	24	10
	< 4	LIGHT	6"	9"	18	10
	4-6	MEDIUM	9"-12"	14"-18"	24	12
	6-8	HEAVY	15"-18"	22"-27"	36	12
	8-10	HEAVY	15"-18"	22"-27"	36	18
24"	< 3	LIGHT	6"	9"	18	12
	3-4	MEDIUM	9"-12"	14"-18"	24	16
	4-8	HEAVY	15"-18"	22"-27"	36	24
30"	< 1	LIGHT	6"	9"	18	15
	1-2	MEDIUM	9"-12"	14"-18"	24	20
	2-4	HEAVY	15"-18"	22"-27"	36	25
	4-6	HEAVY	15"-18"	22"-27"	36	30
36"	< 2	MEDIUM	9"-12"	14"-18"	24	24
	2-3	HEAVY	15"-18"	22"-27"	36	30
	3-5	HEAVY	15"-18"	22"-27"	36	36
42"	< 1	MEDIUM	9"-12"	14"-18"	24	28
	1-2	HEAVY	15"-18"	22"-27"	36	35
	2-3	HEAVY	15"-18"	22"-27"	36	42
48"	< 1	MEDIUM	9"-12"	14"-18"	24	32
	1-2	HEAVY	15"-18"	22"-27"	36	40
	2-3	HEAVY	15"-18"	22"-27"	36	48

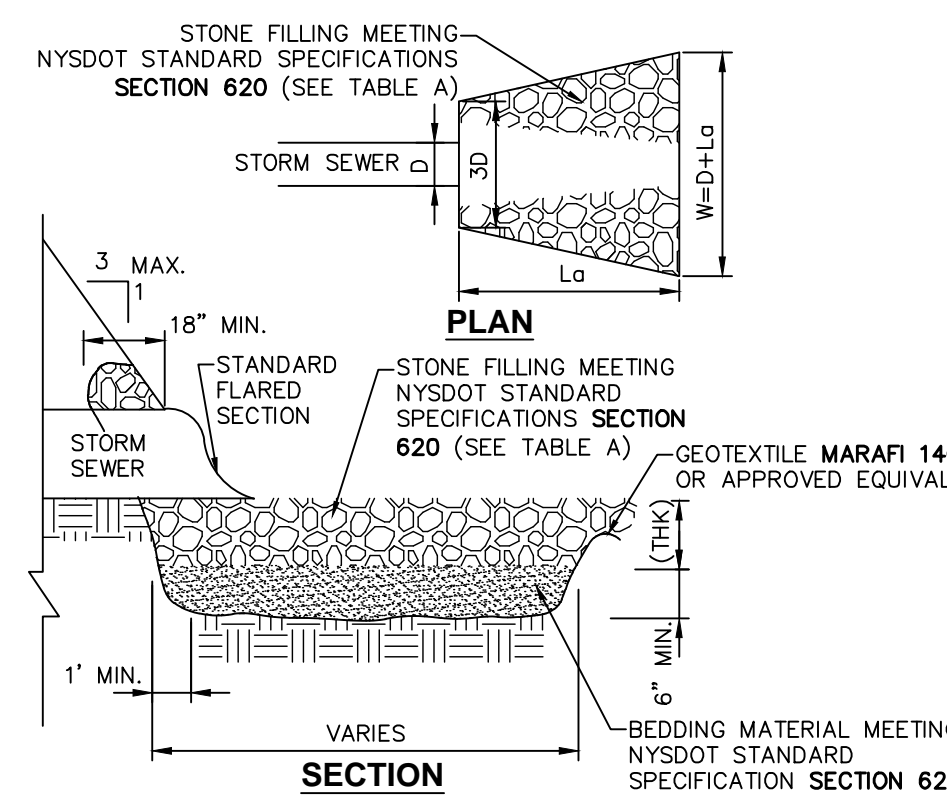

**1 END SECTION WITH STONE LINED APRON DETAIL**  
SCALE: NOT TO SCALE

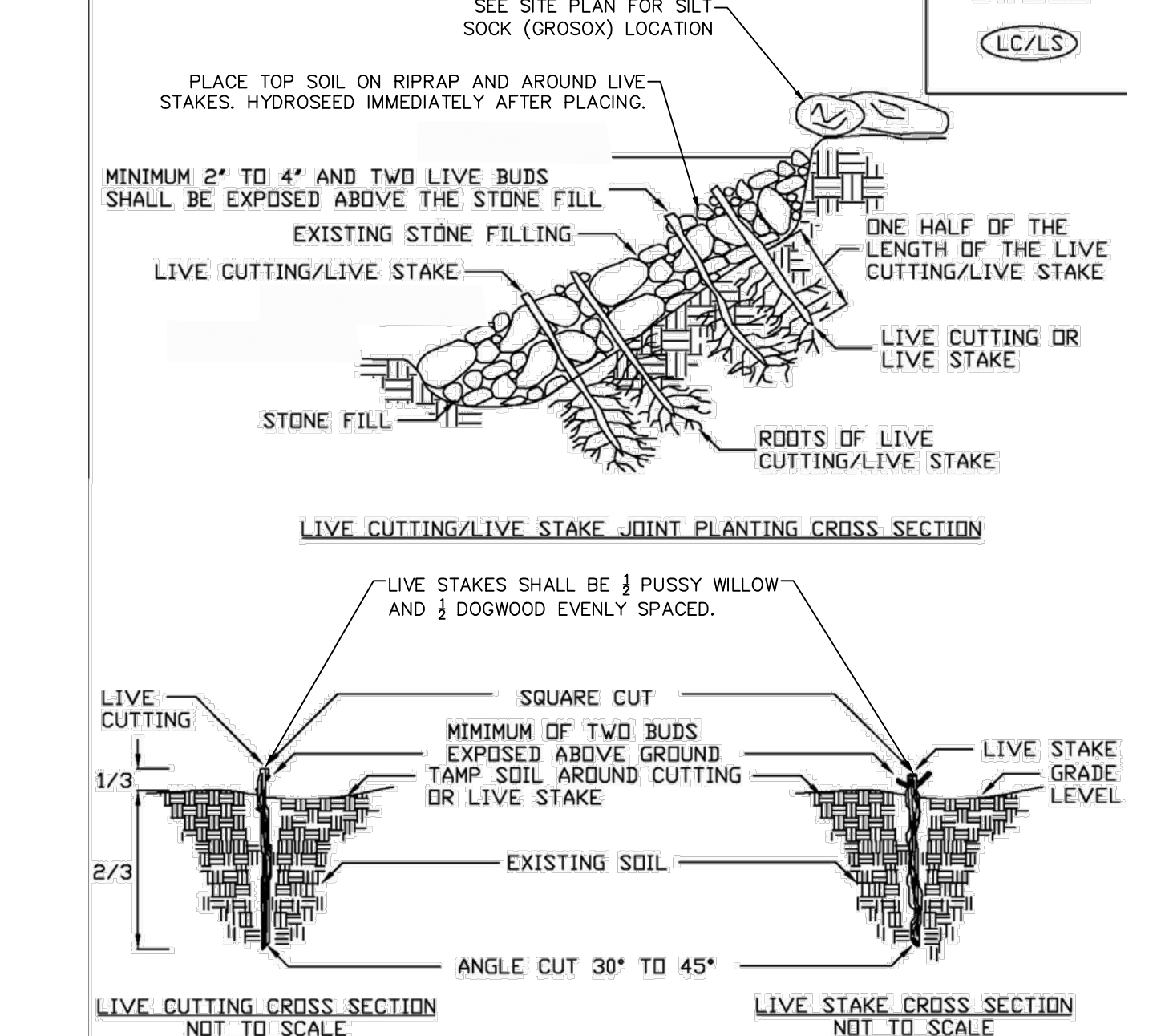

**2 LIVE STAKE & BANK STABILIZATION**  
SCALE: NOT TO SCALE

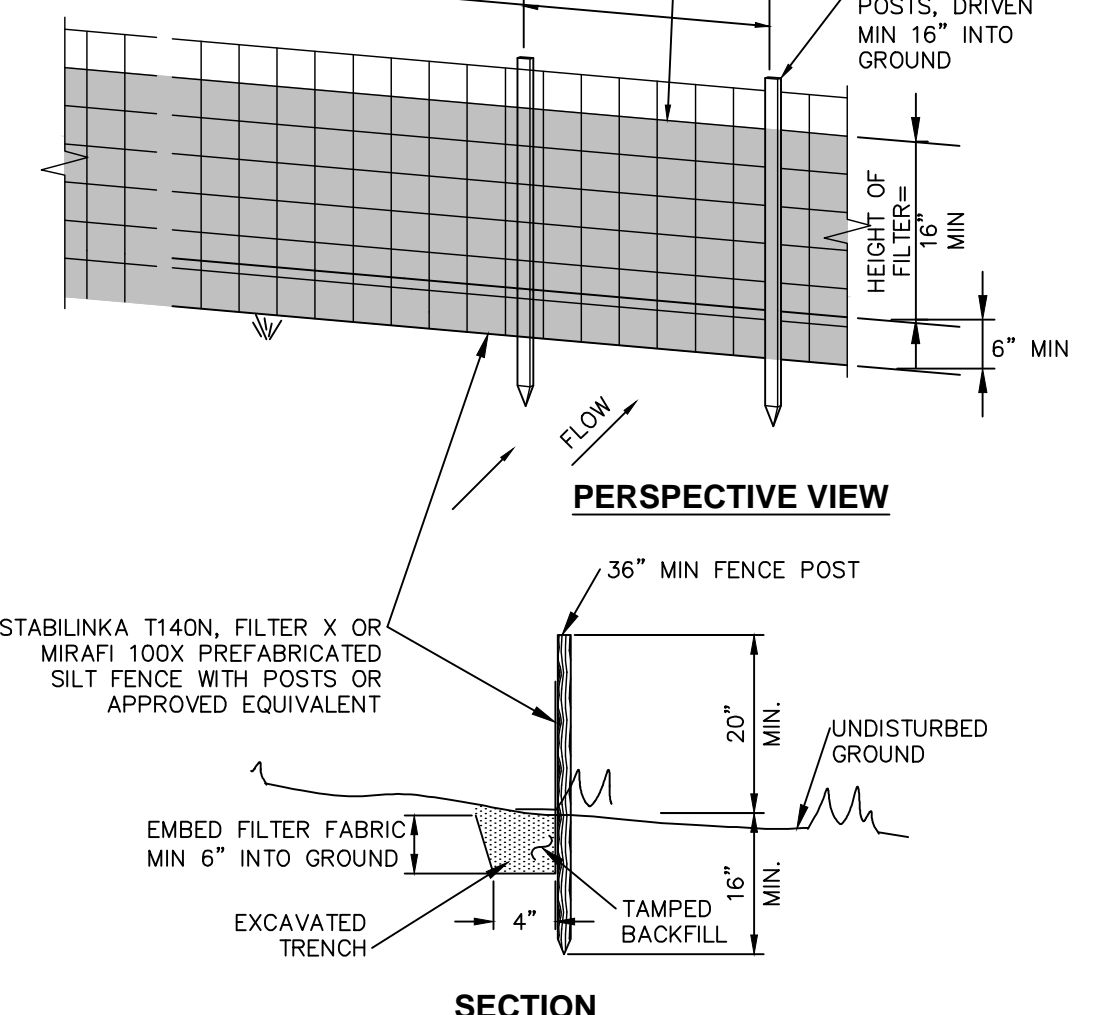

**3 SILT FENCE INSTALLATION DETAIL**  
SCALE: NOT TO SCALE

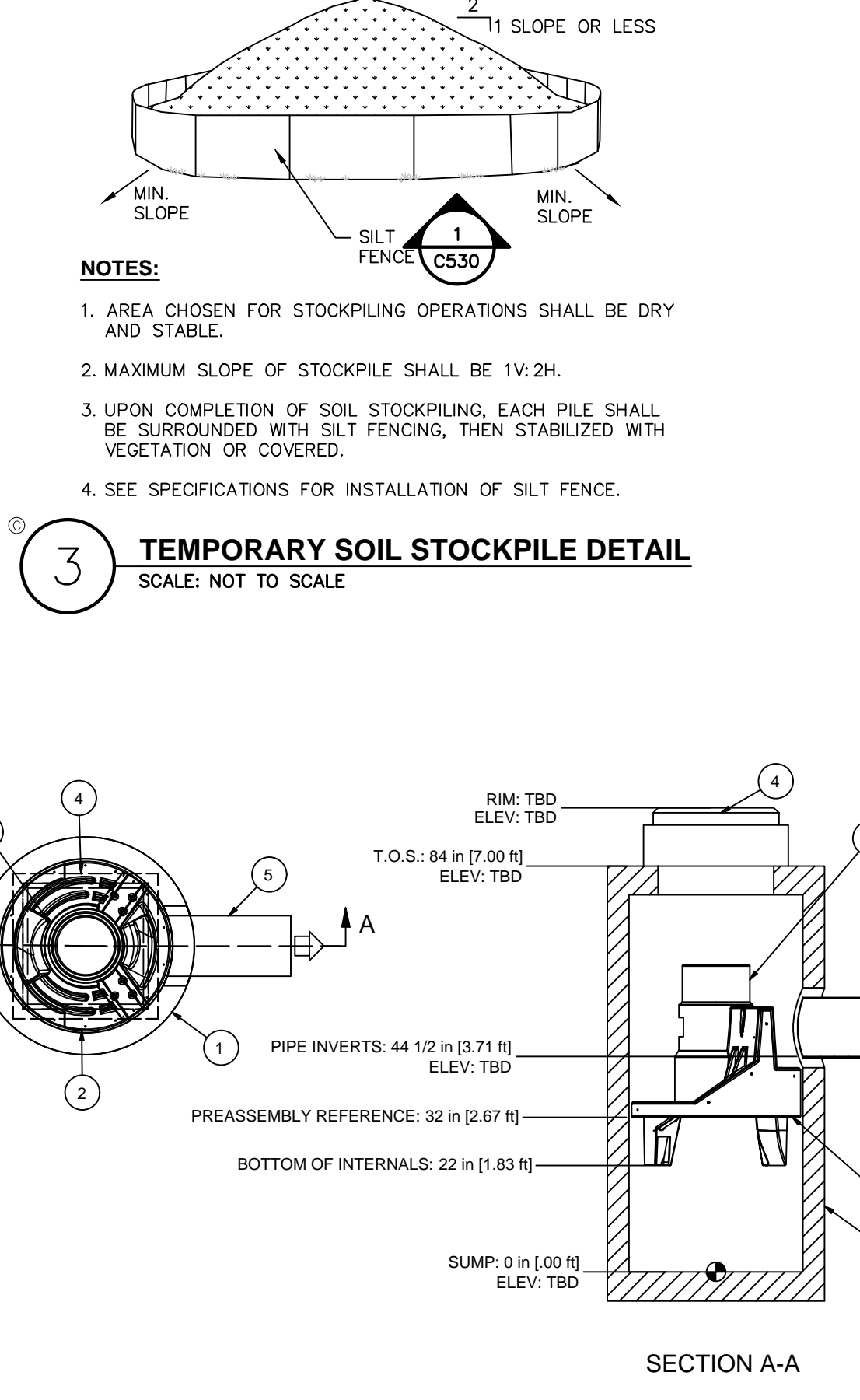

**4 TEMPORARY SOIL STOCKPILE DETAIL**  
SCALE: NOT TO SCALE

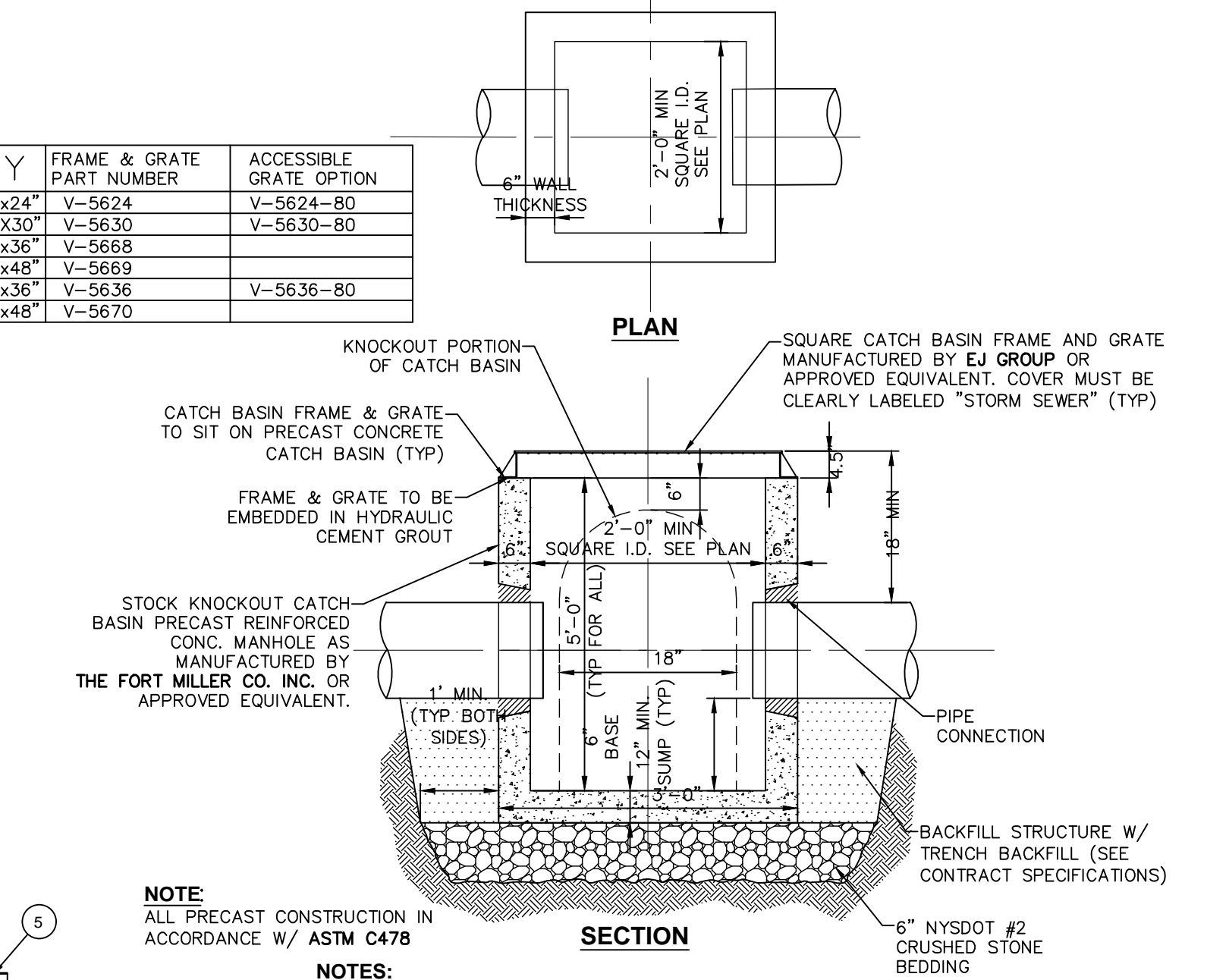

**5 PRECAST CONCRETE SHALLOW CATCH BASIN DETAIL**  
SCALE: NOT TO SCALE

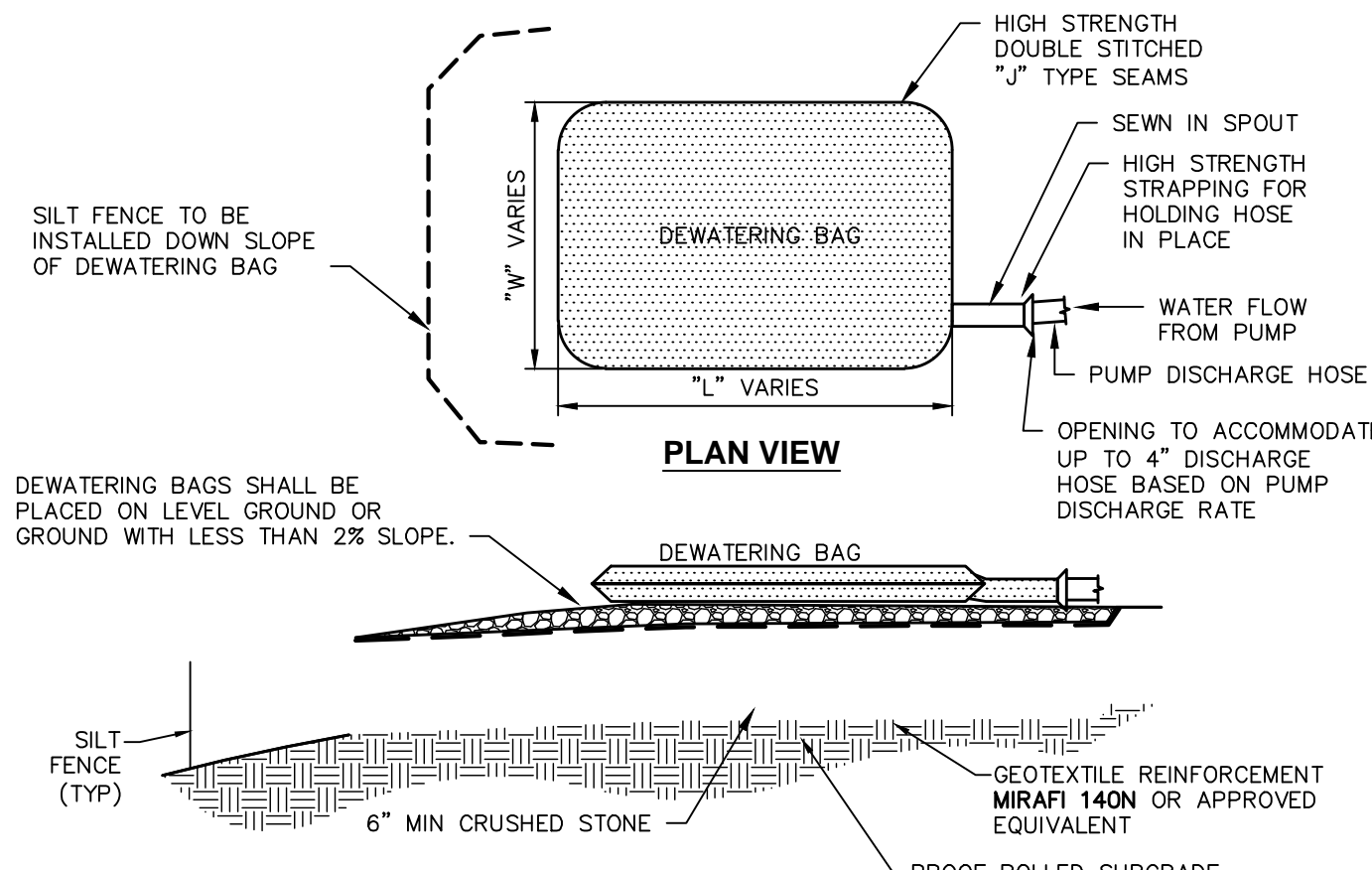

**6 DEWATERING BAG DETAIL**  
SCALE: NOT TO SCALE



**7 DRY WELL DETAIL**  
SCALE: NOT TO SCALE

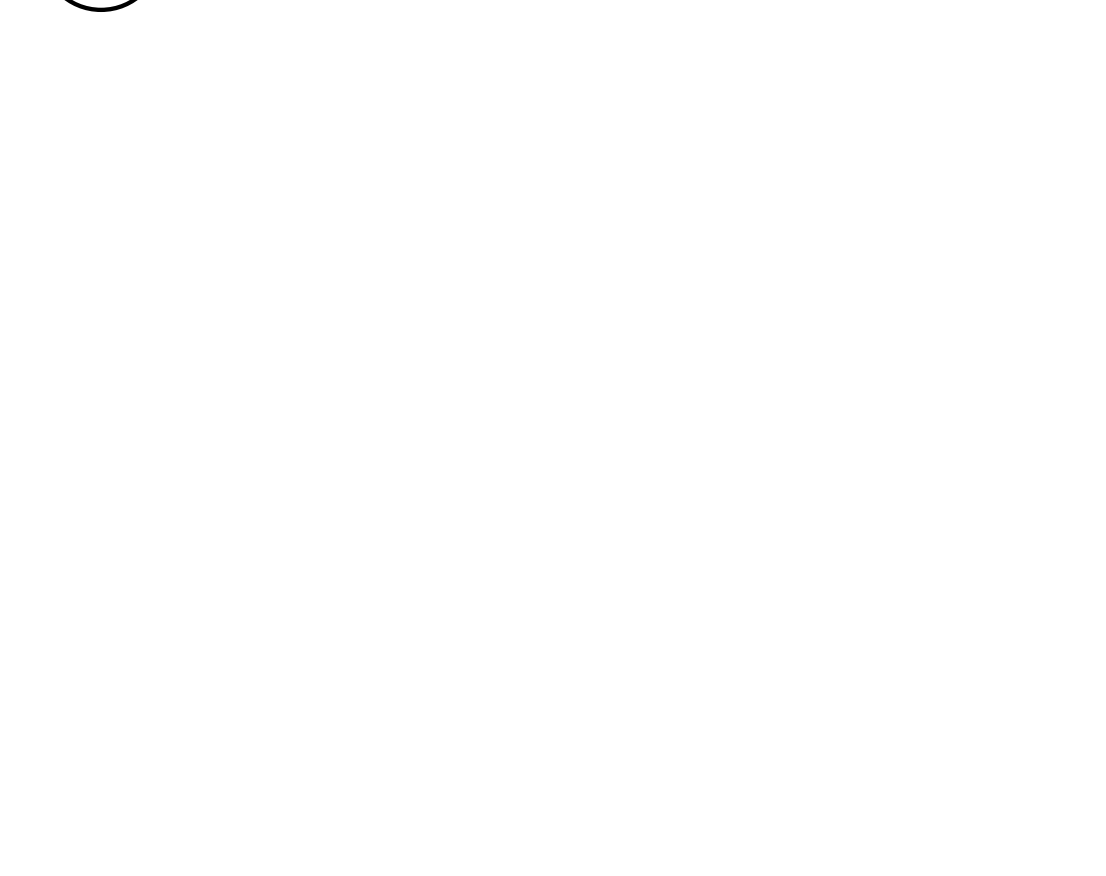

**8 SILT SOCK DETAIL**  
SCALE: NOT TO SCALE

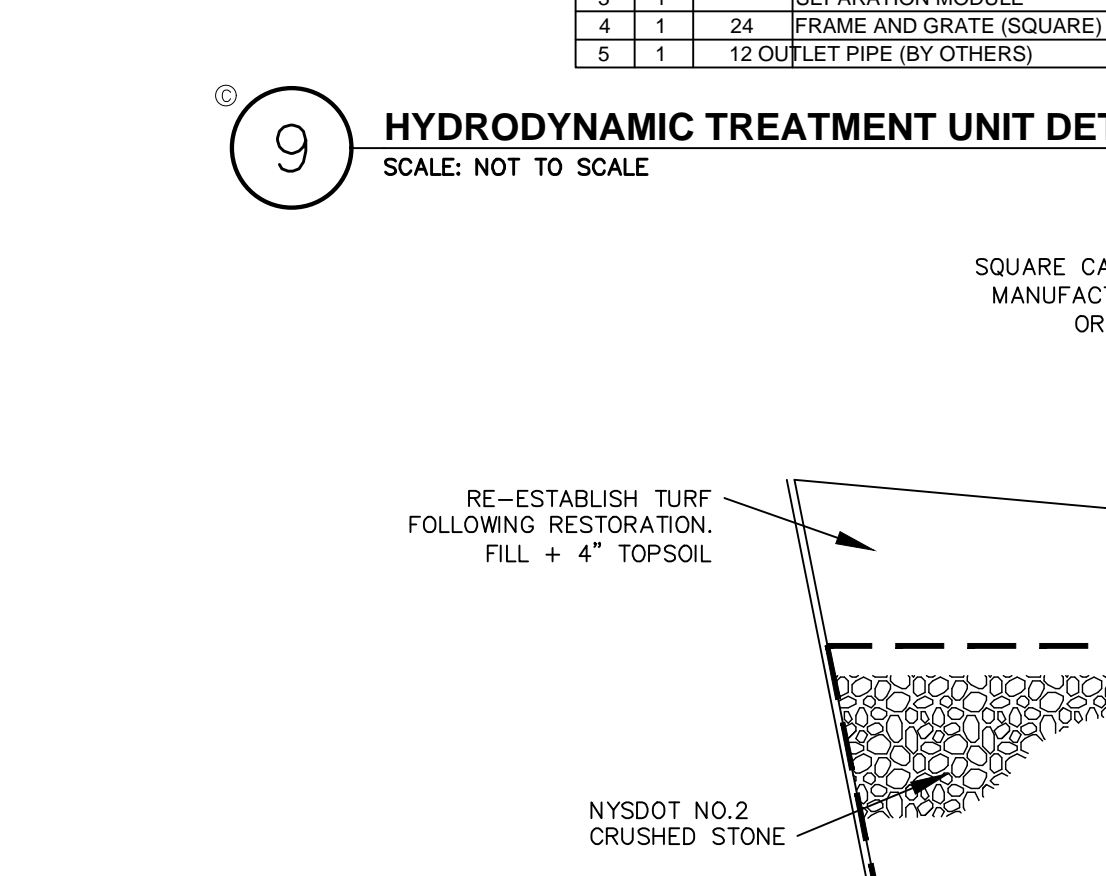

**9 HYDRODYNAMIC TREATMENT UNIT DETAIL**  
SCALE: NOT TO SCALE

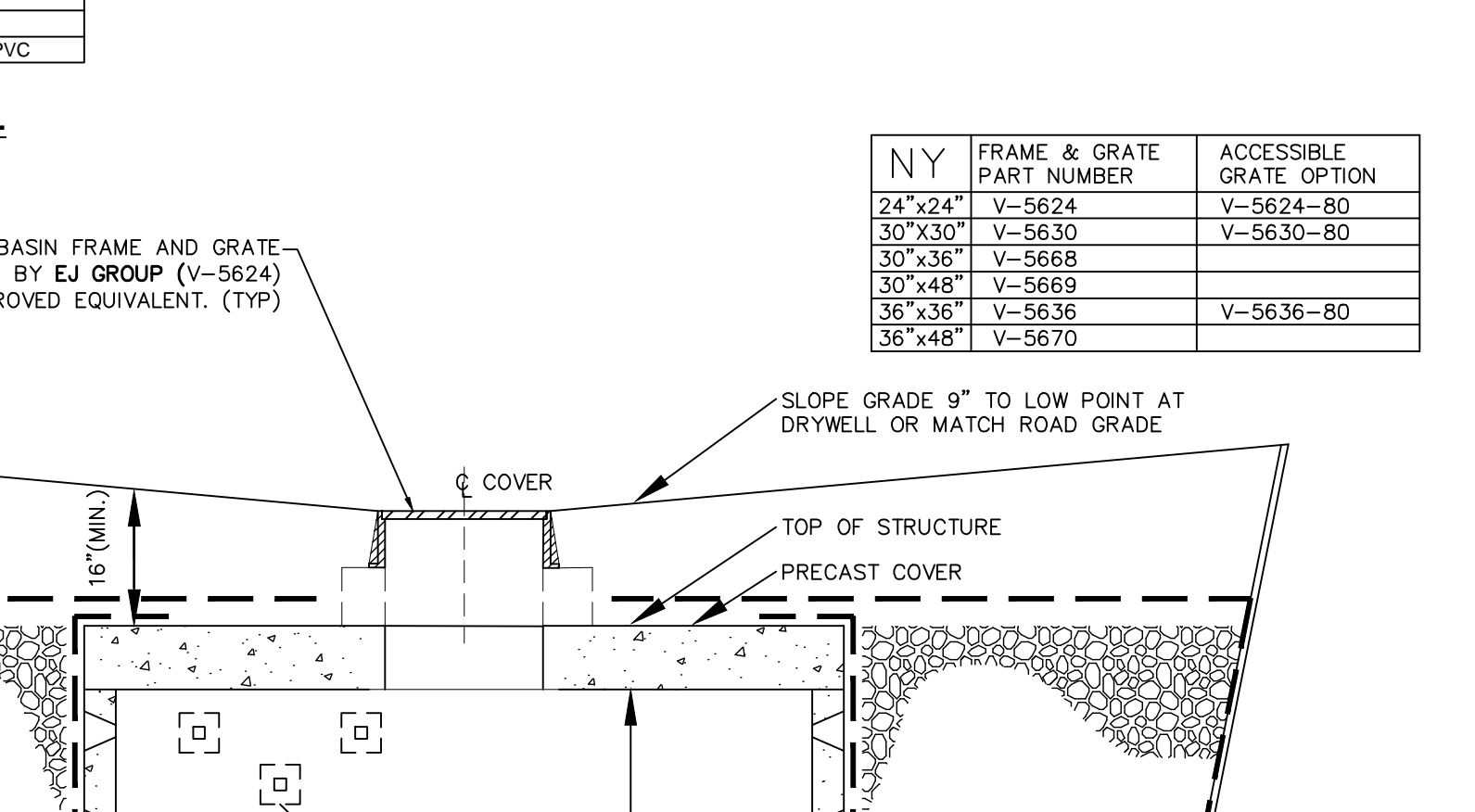

**10 COMPOST SOCK CONNECTION/ATTACHMENT DETAIL**  
SCALE: NOT TO SCALE

**8 DEWATERING BAG DETAIL**  
SCALE: NOT TO SCALE

**6 SILT SOCK DETAIL**  
SCALE: NOT TO SCALE

**3 SILT FENCE INSTALLATION DETAIL**  
SCALE: NOT TO SCALE

**4 TEMPORARY SOIL STOCKPILE DETAIL**  
SCALE: NOT TO SCALE

**7 DRY WELL DETAIL**  
SCALE: NOT TO SCALE

ITEM	QTY	SIZE (in)	DESCRIPTION	TYPE
1	1	36	I.D. PRECAST MANHOLE	
2	1		LEDGER SUPPORT	
3	1		SEPARATION MODULE	
4	1	24	FRAME AND GRATE (SQUARE)	
5	1	12	OUTLET PIPE (BY OTHERS)	PVC

NY	FRAME & GRATE PART NUMBER	ACCESSIBLE GRATE OPTION
24"x24"	V-5624	V-5624-80
30"x30"	V-5630	V-5630-80
30"x36"	V-5668	V-5668
30"x48"	V-5669	V-5669
36"x36"	V-5636	V-5636-80
36"x48"	V-5670	V-5670

SLOPE STEEPNESS	MAXIMUM SLOPE LENGTH (FT)
2:1	25
3:1	50
4:1	75
5:1 OR FLATTER	100

NY	FRAME & GRATE PART NUMBER	ACCESSIBLE GRATE OPTION
24"x24"	V-5624	V-5624-80
30"x30"	V-5630	V-5630-80
30"x36"	V-5668	V-5668
30"x48"	V-5669	V-5669
36"x36"	V-5636	V-5636-80
36"x48"	V-5670	V-5670

LAKEVIEW CIRCLE STORMWATER PROJECTS
designed ZFB
checked
date 01/30/19 AS SHOWN
project no. 91803.03
sheet no. SD-1